

**Rasonic 樂信牌**

**RIC-S211E / RIC-S228E**

**廚房專用雙頭電磁爐 Kitchen Use Double-Burner Induction Cooker**

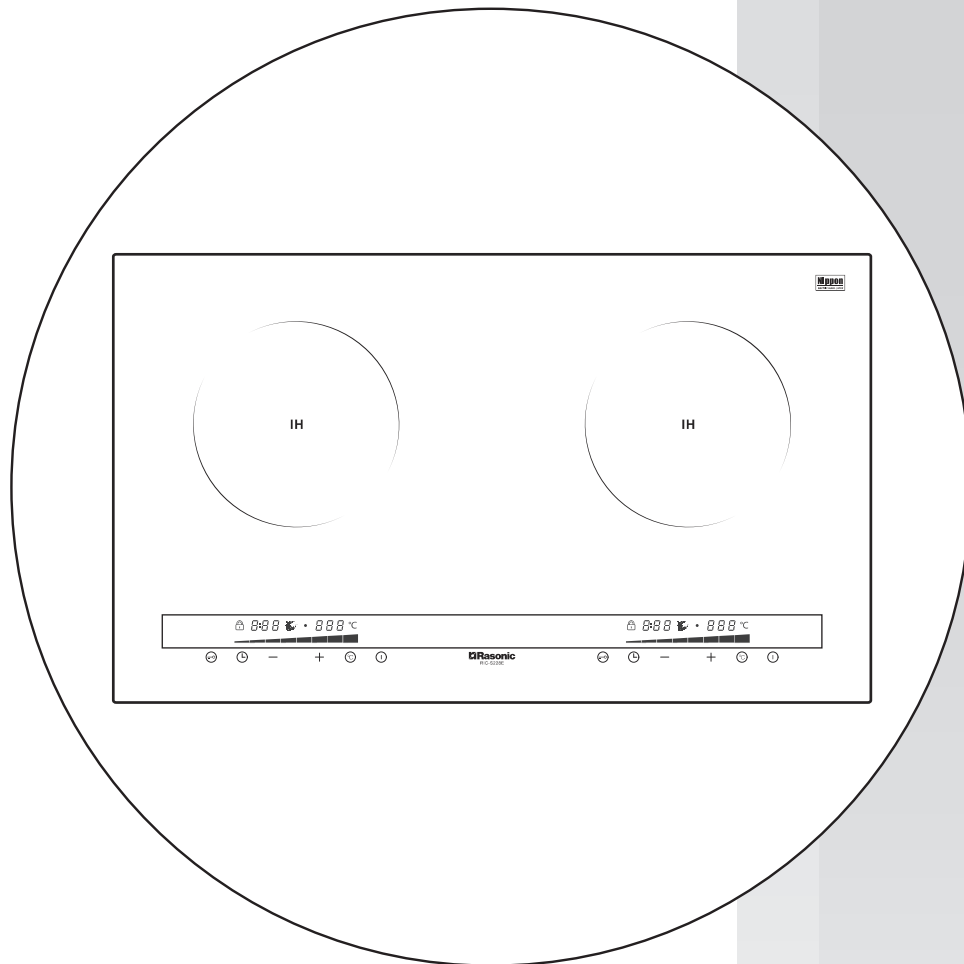

**僅適用於家庭使用  
For household use only**

## **使用說明書 OPERATION MANUAL**

- 在使用本產品前，請仔細閱讀本說明書，並妥善保存本說明書以備用戶日後查詢。  
Please read the operation manual carefully before using and well keep it in a safe place for future reference.
- 本說明書中的圖示可能有與實物不同的地方，僅供參考。  
Some figures in this manual may not match with the real object, just for reference only.

非常感謝您選購樂信牌廚房專用雙頭電磁爐，為了使我們的產品能全心全意服務您，在使用前請先詳細閱讀本說明書，並保存以備日後參考。

## 目錄

1. 安全注意事項
2. 保存及清潔方法
3. 鍋具的選擇
4. 產品規格及結構
5. 控制面板及操作方法
6. 故障排除
7. 特別聲明
8. 售後服務

## 1. 安全注意事項

使用本產品時，必須遵守下列安全預防措施

### 1.1 為了防止火災、灼傷和觸電

#### 使用電磁爐前

1. 請確保當地使用的電壓與本產品上所標明的額定電壓相符。
2. 請使用獨立電源插頭。切勿使用電線拖板，以免因電力負荷過度而導致火警或危險。

#### 安裝電磁爐時

1. 必須將原裝電線連插頭接駁至13安培獨立插座上。如需接駁至固定線路上，必須為13安培或以上的獨立開關掣，並須符合電力條例。
2. 應把產品平穩放置於乾爽的地方，並距離牆壁大於100毫米以上的距離空間作散熱用途。嵌入式安裝時，電磁爐底部須預留不少於150毫米高度，而櫥櫃門亦須有不少於80平方厘米的進／出風口，並請保持排氣口及進風口暢通。

#### 使用電磁爐烹煮時

1. 切勿過度加熱。(使用低火力段預熱。)
  - 如果油量少並且加熱過度，則可能因油溫迅速上升而導致火災發生。
  - 如果鍋具底部很薄且彎曲，則鍋具底部可能會變紅。
2. 切勿讓產品置於無人看管的狀態下運作。
3. 切勿乾燒空鍋，否則容易造成過熱、運作異常及面板變色等問題。

#### 面板及邊框可能變得極熱

1. 在使用時或剛使用後，切勿觸摸。(在[]/[H]餘溫提示燈亮起時，尤其要小心。)
2. 請待冷卻後才清潔本產品。  
(避免在使用後的短時間內觸摸面板，因為鍋具的溫度會令面板仍然保持高溫。)

#### 關於面板

1. 切勿將攜帶式氣體爐、石油氣罐及罐裝食品放在面板上，以防止它們被錯誤加熱而造成爆炸。
2. 必須按本說明書內建議的合適鍋具及確保鍋具底部保持平整及清潔。否則，面板感測器可能失效並導致產品異常升溫，或使產品出現故障並影響其運作。
3. 切勿在電磁爐運行時，將類似刀、叉、湯匙、蓋子、鋁箔或鋁盤等金屬物或導磁性物品，以及蒸煮袋、磁性指環、手錶或飾物等置於面板上或附近位置，或直接接觸鍋具，否則可能造成該物品變熱。(被加熱時所產生的熱量，會造成灼傷或受傷。)
4. 切勿讓面板受到重壓或外來的猛烈撞擊。(例如令重物墜於其上等，有可能導致面板暗處產生裂紋。在沒有接受信興電器服務中心有限公司詳細檢查期間，如產品再度強行運作，可能促使面板爆裂，產生危險。)

\*\*\* 警告：如果面板破裂或受到外來的猛烈撞擊或因重物墜落造成破裂，切勿觸摸。應立即停止使用並關掉電源及拔出電源插頭，立即聯絡信興電器服務中心有限公司進行檢查及維修，以避免造成電擊、短路或火災等危險。

### 鍋具注意事項

1. 電磁爐專用的鍋具只能放在電磁爐上使用。切勿將電磁爐專用的鍋具用於氣體煮食爐上或混合使用，以免影響烹調效果。
2. 放置鍋具前，請確認鍋具底部及面板上沒有水漬、油漬或其他粘附物。如有污漬，請完成清潔後才使用本產品。

### 避免油炸烹飪

1. 本產品不帶油溫控制系統。油炸時，或會因油溫過高而導致火災及損壞內部電子組件，故油炸時應緩慢加熱，並留意加熱情況。
2. 若煮食油或脂肪加熱時起火焰，應立即關閉電源。切勿用水滅火，應使用合適的滅火器或使用滅火毯。

### 爐頭注意事項

1. 切勿將易燃材料、噴霧劑及煙霧劑等放在產品下方或附近，否則可能導致火災或爆炸。
2. 切勿讓不習慣操作本產品的人獨自使用。
3. 本產品並不為體質、感覺或智力有障礙人士或缺乏經驗(包括小孩)或相關知識的人士使用，除非他們曾經接受負責安全人士的監督或指示。
4. 切勿加熱密封的罐頭食品，以防罐頭內的氣體受熱膨脹而發生危險。
5. 請時常留意烹調情況及溫度，避免過熱或乾燒。否則操作時可能因溫度過高，使安全保護功能自動啟動並停止運作，影響烹調效果。
6. 若有孩童在旁，須加倍小心使用產品及看管小孩，以確保他們不會把此產品當作玩具。切勿讓小孩單獨使用及將本產品及其電源線置於他們可能觸及的地方。
7. 切勿讓嬰兒靠近。
8. 切勿將金屬物件(如針或金屬線等)插入產品的進風口／排氣口。
9. 切勿使用外置計時器或遙控系統來操作本產品。
10. 煮食時，鍋具必須放置於烹調區域的中央位置上面。鍋具與面板中間不應夾雜紙品或其他物件，讓鍋具直接受熱。(由於鍋具的熱量，物件或會因此而燒毀。)
11. 產品內有高壓電，切勿拆卸、試圖維修或改裝本產品，以免釀成意外。如須檢查或維修，請與信興電器服務中心有限公司聯絡。
12. 如發現附帶的電線有破損，必須聯絡信興電器服務中心有限公司更換，以免發生危險。

### 使用後，緊記切斷電源

1. 使用後，按[①]鍵關掉產品。如機體尚有餘溫，待散熱風扇完全停止運作後才拔掉電源插頭。切勿依靠面板感測器關掉產品。
2. 長時間不使用時，請關掉本產品的電源及拔出電源插頭，避免因長時間通電導致內部電子組件損毀，甚至引起火警。
3. 請保持產品清潔，並注意防蟲、防塵、防潮的保護，避免蟑螂等昆蟲進入電磁爐內部造成電路板短路。

### 1.2 防止火災或發生意外

#### 為避免發生意外，請注意下列各項

1. 請注意！加熱時偶爾會噴濺出材料或熱水，這種現象被稱為溢瀉。尤其是炆煮及加熱時，請使用低火力烹調及時刻留意食物烹調情況。
2. 如果你佩帶心臟起搏器或除顫器人士，請諮詢醫生。（本產品的使用可能會影響心臟起搏器或除顫器運作。）
3. 保持鍋具平穩。（如果鍋具掉下來，可能會導致損傷或灼傷。）
4. 切勿加熱空煲或過度加熱。（食材可能會燃燒，進而損壞鍋具。此舉或會損壞產品本身及面板，甚至造成災害。）
5. 遠離大量熱氣、蒸氣或濕熱地方；切勿將產品安裝於靠近水源的地方，防止機身進水。
6. 切勿用水直接沖洗產品機身、電源線或插頭，讓它們接觸到水或讓液體滲入產品帶電部分；在清潔時亦不可把部份或整部產品浸入水中，以免影響產品的安全性能及造成觸電的危險。再次使用前，必須確保插頭充分乾燥。
7. 小心使用電源線，不可在電源線上放置重物或夾住電源線；不可改裝、用力拉扯或扭曲電源線；在拔出或插入插頭時，應手握穩插頭，並確保將插頭插穩。
8. 切勿將電源線懸掛在桌子、櫥櫃的邊緣或令它接觸發熱的表面。切勿在電源線纏結的情況下使用本產品，否則會加快電源線的損耗。
9. 電磁爐不能安裝在洗碗機、洗衣機、乾衣機、焗爐或冰箱之上，因為產品散發出的熱量會損壞安裝於下面的電子設備。
10. 切勿於同一時間按兩個或以上的功能鍵，亦不要讓熱的物件接觸控制面板，因為這會令產品出現錯誤的反應。
11. 切勿以濕手操作本產品、插入或拔除插頭。
12. 切勿將本產品用於烹飪以外的其他用途。（用於烹飪以外或會發生故障。）
13. 本產品是家用或在類似環境使用，如：商店內部、辦事處以及其他類似工作環境的廚房區域；客戶在旅館、汽車旅館和其他住宅類型的環境。
14. 本產品只可作家庭或類似環境使用，切勿在室外使用或用於說明書建議以外的其他用途。使用不當，或作(半)商業用途，或未依照使用手冊操作，維修保養將告無效，本公司將不會承擔任何損壞的維修及賠償。
15. 當產品機身或零件出現故障，或不能正常操作，切勿自行使用或更換其他非生產商授權的零件或配件，以免發生危險，否則維修保養無效。
16. 遵從安全守則及避免釀成意外，如需檢查或維修產品，請聯絡信興電器服務中心有限公司（地址印於本說明書的背頁或致電 2406 5666），並確保在檢查或維修時出示保修登記卡及收據。

### 1.3 使用電磁爐時

**本產品會釋放出磁力線，請將任何容易受磁力影響之物品移離本產品**

1. 收音機、電視機、助聽器等。(因為它們容易受到干擾。)
2. 磁卡、磁帶車票、銀行卡等。(因為它們的記錄可能被清除或損壞。)

**切勿將本產品放置在其他電磁感應設備或任何金屬表面上／附近使用**

1. 電磁感應電飯煲、攜帶型電磁感應煮食爐等。(因為磁場可能會損壞本產品。)
2. 切勿放置於金屬檯面(或金屬表面)上使用，以免導致金屬材料或檯面被錯誤加熱而引起電磁爐機殼發熱及造成危險。

**加熱時鍋具發出噪音**

1. 根據使用鍋具的類型，使用時或會聽到鍋具的共鳴聲。
2. 握住鍋具手柄時，可能會感覺到微小的振動。
3. 加熱時如果移動鍋具，可能會聽到短促的金屬聲。

(輕微移動鍋具或更換鍋具有助減低以上提及的振動及鳴聲現象。為免灼傷，切勿直接觸摸鍋具的金屬部分。)

**切勿在本產品下方的櫥櫃內存放調味料及食物**

本產品排氣口釋放的熱量可能會使它們受損。

**如果酸性食物黏在面板或邊框上，請立即清潔**

切勿讓醋、果醬、帶有檸檬汁的食物或梅子等食物黏在面板或邊框上。(否則，面板或邊框可能會褪色或受損。)

**切勿用鍋底摩擦面板**

面板可能會損壞或褪色。

**切勿堵住進風口／排氣口**

(進風口／排氣口被堵塞會造成過熱，導致產品自動關閉或引致其他災害。)

1. 進風口位於本機的底部，而排氣口位於本機的背部位置。
2. 請勿將本產品放置於地毯、檯布、紙品或墊子等物件上使用。(如果堵塞進風口／排氣口，或會造成故障。)

### 切勿使用蒸氣清潔器清潔本產品

若本產品的帶電部件進水，有可能造成故障或其他災害。

#### 1.4 使用[8]段火力加熱注意事項

1. 由於輸出功率大，如油量過少且過度加熱，鍋具會快速受熱，油溫會因迅速上升而導致意外發生。
2. 由於輸出熱力太強，可能會造成鍋具底部彎曲變形。如使用的油量少或鍋具底部較薄時，應使用低火力預熱。
3. 煲水時，水一旦沸騰，請立即降低火力(水有可能會沸騰溢出或噴濺。)
4. 若使用[8]段火力烹調食物達至沸騰，切勿再加入新食材(食料或會煮沸溢出。)
5. 請注意！[8]段火力只能短暫維持，連續使用約10分鐘後火力會自動調低至[7]段，以保護本產品。

## 2. 保存及清潔方法

1. 清潔前，請先按[⏻]鍵關上本產品及拔出插頭。
2. 面板的清潔：面板骯髒時，用扭乾的濕布擦拭。如擦不掉時，用稀釋的中性廚房去污粉或清潔劑清潔後，再用濕布擦拭即可。
3. 機身的清潔：機身骯髒時，用柔軟濕布擦拭。如有油污難以清除時，用稀釋的中性廚房洗潔劑清洗後，再用濕布擦拭即可。
4. 切勿使用蒸氣清潔工具進行清潔。
5. 經過長時間使用，進風口／排氣口會囤積一些灰塵或油污，並可能影響產品運作。建議定期使用棉花棒進行清潔。
6. 如有任何塑膠物料、廚房用錫紙、糖類或含有糖的食品不小心融化於發熱的面板上，必須在面板仍是溫熱時，用柔軟濕布擦拭，否則冷卻後才清潔或會損壞陶瓷面板。
7. 切勿使用堅硬刷子刷洗爐面，並避免碰撞面板。
8. 切勿使用有機溶劑或苯等化學藥品擦拭產品及其面板／控制面板，以免發生化學反應。
9. 經常清潔鍋具底部及產品面板。面板可能因使用不當(如使用不潔淨底部的鍋具加熱或加熱湯水外溢且未及時擦淨)而產生發黃、發黑或劃痕等現象。按本說明書操作並做好日常保養，可避免或減少此類現象發生。
10. 長期不使用時，請拔下電源插頭，進行清潔後套上塑膠袋並收藏於乾燥的環境。切勿將電源線纏繞在產品四周或壓住電源線，避免造成電源線磨損或破裂。

### 3. 鍋具的選擇

#### 3.1 合適的鍋具(使用磁鐵可以有效分辨鍋具是否有磁性)

1. 材質：鐵或導磁不鏽鋼為底的鍋具。必須使用註明“適合電磁爐煮食”的鍋具。
2. 形狀：底部直徑必須在120-200毫米範圍的鍋具，並與面板接觸均勻。
3. 鍋具重量(連盛載食物)每邊爐頭不能超過6公斤。



不鏽鋼水壺



鐵製鍋

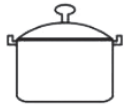

磁性不鏽鋼鍋

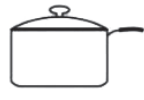

鐵製彩色鍋



磁性鐵製琺瑯壺



鐵板鍋

#### 3.2 不合適的鍋具(磁鐵不能黏在鍋具底部)

1. 材質：非鐵質金屬、不鏽鋼(底部不能導磁)、陶瓷、玻璃、鋁或銅為底的鍋具。
2. 形狀：底部凹凸差距過大者、有弧度、鍋底有腳、鍋具底部為圓形及底部直徑小於12厘米或大於20厘米。
3. 即使標示為磁應加熱用的陶製鍋具，可以用於電磁爐上加熱，也不建議使用。因本產品可能無法有效分辨鍋具是否有磁性而無法加熱、導致操作不穩定、影響煮食效果或令產品啟動其安全保護功能及出現錯誤訊息。



鋁製水壺



耐熱玻璃鍋



陶鍋



底部凹凸不平



鍋底直徑較小



鍋底附腳

## 4. 產品規格及結構

### 4.1 產品規格

型號	RIC-S228E	RIC-S211E
額定功率(約)	總功率：2,800瓦(火力共享) 左/右爐獨立最高火力：2,800瓦	
額定電壓	220伏特~ 50赫茲	
產品尺寸(約) 闊 x 深 x 高	735 x 435 x 80 毫米	650 x 346 x 78 毫米
淨重(約)	11公斤	9公斤
鍋具尺寸要求	鍋底直徑120-200(毫米)	

### 4.2 產品結構

#### 正面

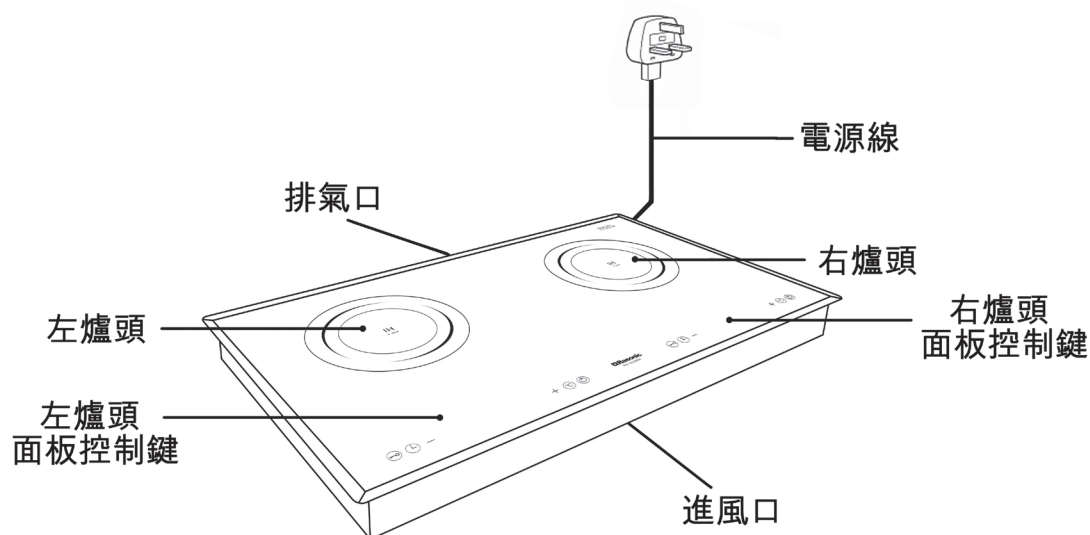

註：各電磁爐的結構大致相同，以上圖片僅供參考。

## 5. 控制面板及操作方法

### 5.1 面板設計

RIC-S228E面板

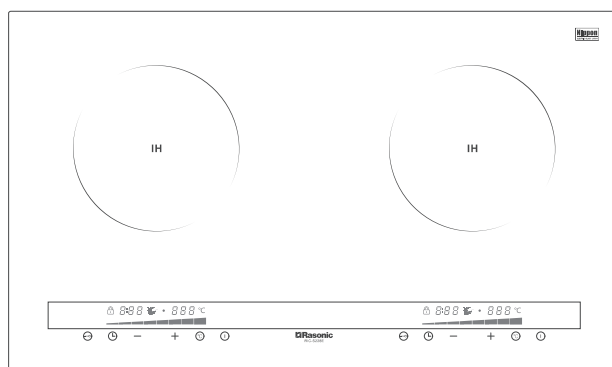

RIC-S211E面板

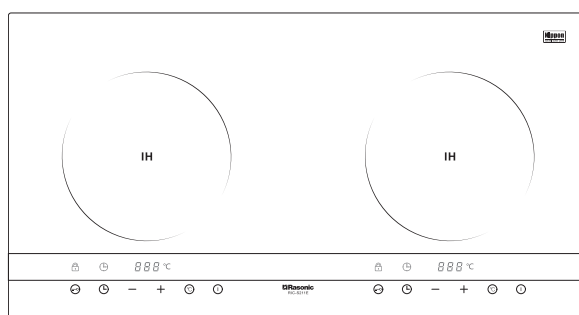

### 5.2 控制面板

RIC-S228E控制面板

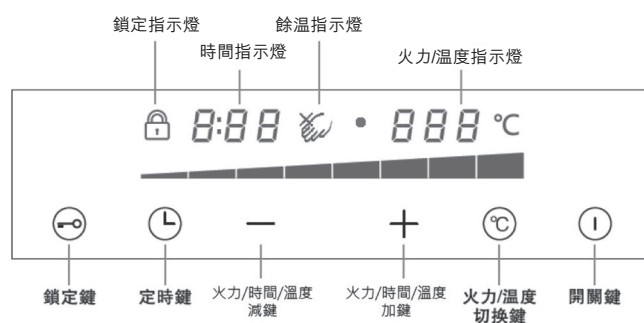

RIC-S211E控制面板

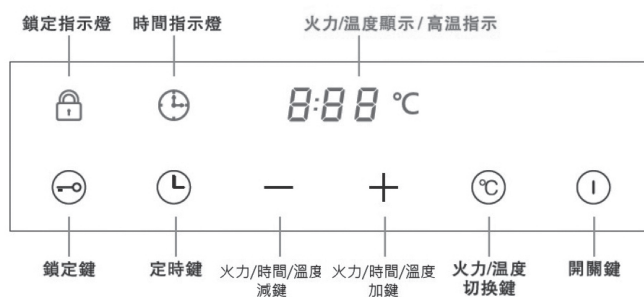

(注意：保持控制面板清潔乾爽，否則控制鍵的電子感應功能可能會失效或出現錯誤運作。)

### 5.3 火力及溫度調控

段數	1	2	3	4	5	6	7	8
溫度模式(°C)(約)	60	90	120	150	180	200	220	240
火力模式(瓦)(約)	250	400	600	1,000	1,400	1,800	2,200	2,800

- \*\*\* 注意：1. 以上火力及溫度，是對應實際功率和溫度於設定程序周期內的平均值。  
2. [8]段火力只能短時間維持，運作約10分鐘後便會自動降至[7]段。

接上產品電源，蜂鳴器鳴響一聲，所有指示燈都會亮起一秒然後關掉，稱為待機狀態。長按[ⓘ]鍵，顯示屏顯示[0]並閃動，表示產品進入備用狀態。用戶可按[+]或[°C]鍵選擇火力或溫度模式。如1分鐘內沒有按下任何功能鍵，顯示屏將會熄滅，表示本產品已返回待機狀態。

#### 火力模式

接上產品電源後，按一次[ⓘ]鍵，電磁爐發出一聲[嗶]聲，顯示屏顯示[0]。放置合適的鍋具於陶瓷面板上，按一次[+]鍵，火力顯示屏會出現預設火力[4]或對應火力段數，表示本產品已進入第4段火力加熱。用戶可按[+]或[-]鍵自行調校合適的火力段數。本產品左右爐頭各有8段火力可供調節。

#### 溫度模式

長按一次[ⓘ]鍵，顯示屏顯示[0]，放置合適的鍋具於陶瓷面板的烹調區域上，按[°C]鍵一次，顯示窗會出現預設溫度[60°C]，即表示本產品已進入60°C溫度加熱。用戶可按[+]或[-]鍵自行調校合適的溫度段數。本產品左右爐頭各有8段溫度可供調節。

本產品左右爐頭使用火力共享原則加熱運作。如用戶同時使用左右爐頭，而其中一邊爐頭調至[8]段火力，另一邊爐頭將會自動停止原有操作。

注意：如設定火力或溫度後未有放置合適的鍋具，本產品將會不斷發出鳴響，顯示屏所設定了的火力段/溫度值會不停閃動以提醒用戶。若1分鐘內未有放置合適鍋具，產品將自動返回待機狀態。

## 定時功能

若需要設定烹煮時間，設定火力段／溫度值後按一次[]鍵，顯示屏的[0:00]亮起。用戶可按[+]或[-]調較時間(設定時間由1分鐘至8小時)當所設定的時間到達[0:59]後，如再按[+]鍵一次，時間會轉為[1:00]，表示[定時]設定由59分鐘轉為1小時。長按[+]或[-]鍵可快速調整時間，由每次增加或減少1分鐘，加速至每次增加或減少10分鐘。





**RIC-S228E:** 選定時間後，若10秒內沒有其他設定，顯示屏的時間指示燈會停止閃動並自動確認。如用戶需要修改定時時間，可按[]鍵一次，剩餘時間會再次閃動，按[+]或[-]鍵重新設置所需的[定時]時間。完成設置靜待10秒後，產品會自動確認並進行操作。



**RIC-S211E:** 選定時間後，產品會直接確認並進行操作。如用戶需要修改定時時間，可直接按[+]或[-]鍵重新調整[定時]時間。如用戶需要修改火力段／溫度值，可按[]鍵一次，顯示屏會出現對應火力段／溫度值，用戶可按[+]或[-]鍵重新調校火力段／溫度值。完成設置靜待10秒後，產品會自動確認並進行操作。

[定時]時間會以倒數計時方式顯示剩餘時間。當倒數完畢後，產品於蜂鳴器發出一聲鳴響後停止運作，顯示屏會出現[End]字樣。



如用戶需要取消定時時間，可長按[]鍵2秒或直接按[]鍵取消定時功能。

## 安全鎖功能

為防止兒童觸碰或其他意外觸碰而啟動或更改操作模式，使用加熱功能後，可長按[]鍵2秒鎖定功能鍵(包括[+]、[-]、[]鍵及[]鍵)使之不能更改火力或時間。在安全鎖啟動狀態時，顯示屏的安全鎖指示燈[]會亮起。

在備用狀態下，安全鎖處於解鎖狀態。此時，長按[]鍵2秒以鎖定所有功能鍵，顯示屏的安全鎖指示燈[]亮起，表示產品處於鎖定狀態，產品不能啟動加熱模式。長按[]鍵2秒解鎖，蜂鳴器鳴響一聲，產品可重新啟動操作模式。



若同時啟動[定時]及[安全鎖]功能，顯示屏仍會顯示剩餘時間。所有按鍵均會被鎖定[]鍵除外]。如需要恢復有關功能鍵，長按[]鍵2秒解鎖即可。

如用戶於鎖定狀態下直接按[]鍵停止加熱，安全鎖指示燈[]依舊會亮起，直至用戶解鎖為止。若用戶再次啟動本產品時仍處於鎖定狀態，必須按[]鍵解鎖，才可重新啟動操作模式。如直接截斷電源再重新接上，[安全鎖]功能將會自動解除，重新開啟後可即時調節火力、溫度及時間。

## 自動關機功能

運作過程中，如120分鐘內沒有按任何按鍵操作及沒有定時設定，產品會自動停止加熱以確保安全。自動停止操作前會有一聲蜂鳴以提示用戶。如用戶需要使用超過120分鐘，請使用定時功能。

## 散熱風扇延時轉動

加熱過程中，散熱風扇會持續轉動，直至用戶完成烹飪後按[]鍵關機，顯示屏的餘溫指示燈[]會閃動/[H]會亮起，然後產品返回待機狀態。散熱風扇會根據機體內部溫度延時轉動一段時間，用以排除機內的熱氣。

## 餘溫提示功能

關機後，如面板溫度處於約50度或以上，餘溫提示燈[]會閃動/[H]會亮起，表示爐面尚有餘溫，切勿觸摸。

## 故障代碼

當產品使用不當或發生問題時，相關故障代碼(E1-E7)會顯示於數碼顯示屏上，產品會停止加熱同時蜂鳴器會鳴響。(詳情請參考標題6.故障排除。)

## 6. 故障排除

使用時，如發現產品操作上有問題，在維修前請先對照下表進行檢查及處理。

故障現象	檢查要點	處理方法
接通電源後，按[⏻]鍵後產品不運作，控制面板及顯示屏的燈熄滅。	是否停電？	電力恢復後使用。
	保險絲是否斷路？	小心檢查原因。若有需要，請聯絡信興電器服務中心有限公司進行檢查及維修。
	電源線插頭是否鬆脫？	
產品不運作，並出現E7。	控制面板是否有積水？	用乾布擦乾控制面板的積水。
	控制面板是否被有抹布或導磁性物體遮蓋？	將抹布或導磁性物體移離控制面板。
產品不加熱，並發出間歇性蜂鳴聲。	鍋具是否不適合電磁爐使用？	使用電磁爐適用的鍋具。
	鍋具是否置於烹調區域的中央位置？	將鍋具放到爐頭加熱區中央位置上。
	加熱的鍋具是否經常被移走？	將鍋具放到爐頭適當的位置上。
產品加熱期間停止運作並出現E4。	電磁爐安裝不正常，通風散熱不良。	按要求安裝，並保持通風良好。
	電磁爐進風口或排氣口有否被堆積髒物而阻塞？	清除堵塞在進風口／排氣口處的污物，並請保持通風口暢通。
	電磁爐風扇是否停止轉動？	請聯絡信興電器服務中心有限公司進行檢查及維修。
	電磁爐使用環境溫度過高。	待產品降溫後，再嘗試重新啟動本產品。
產品加熱期間停止運作並出現E3。	是否空鍋乾燒？	將食材放在鍋具內，或待降溫後再嘗試重新啟動本產品。
	被加熱食材及鍋具溫度過高？	降低火力／溫度段，或待降溫後再嘗試重新啟動本產品。
產品加熱期間停止運作並出現E1或E2。	輸入電壓與額定電壓是否不符？	請確保當地使用的電壓與本產品上所標明的額定電壓相符。
產品加熱期間停止運作並出現E5及E6。	溫度傳感器故障	請聯絡信興電器服務中心有限公司進行檢查及維修。

### 故障代碼

- E1－供電電壓過低
- E2－供電電壓過高
- E3－爐面溫度過高
- E4－機內溫度過高
- E5－爐面溫度傳感器故障
- E6－內部溫度傳感器故障
- E7－控制面板維護

如按照以上處理方法／操作仍未能修復問題，請即時關閉電源，聯絡信興電器服務中心有限公司(電話：2406 5666)進行檢查及維修，並將故障代碼告知信興電器服務中心有限公司。切勿自行拆卸及修理產品，避免產生觸電危險及對產品造成損害。

## 7. 特別聲明

1. 本資料上所有內容經過核對，如有任何印刷及內容上的誤解，本公司將保留解釋權。
2. 本產品若有技術改進，會編進新版說明書中，恕不另行通知；產品外觀、顏色如有改動，皆以實物為準。
3. 如本資料之中英文版本有差異時，應以中文版為準。
4. 使用說明書的電子副本可以經電子郵件發送至用戶，如有需要，可致電信興電工工程有限公司：2861 2767。

## 8. 售後服務

用戶自購買日起一年內，若產品於正常使用的情況下發生故障，本公司將提供免費保修服務。用戶請於維修時出示購買收據/換購收據及蓋有銷售點/換購點印章的產品保修記錄卡。如有任何疑問，請致電信興電器服務中心有限公司熱線查詢:2406 5666。

Thank you for purchasing Rasonic Kitchen Use Double-Burner Induction Cooker. Read the operation manual carefully before using and well keep it for your later reference.

## Table of Contents

1. Important Safeguards
2. Maintenance and Cleaning Methods
3. Cookware for Induction Cooker
4. Product Specifications and Configuration
5. Control Panels and Operation Instructions
6. Troubleshooting and Treatment
7. Special Avowal
8. After Sales Service

## 1. Important Safeguards

When using the appliance, please follow the basic safety precautions:

### 1.1 To prevent fire, burn or electric shocks

#### Before using the induction cooker

- 1 Make sure the input voltage match the rated voltage marked on the appliance before operation.
- 2 Use an independent socket for the appliance. Do not use extension cords to avoid overload and risk of fire.

#### When install the induction cooker

1. Connect the provided power cord with the plug of the appliance to 13A socket. If fixed wiring connection is needed, connection must be incorporating with an individual switch with 13A or above in accordance to the Electricity Ordinance.
2. The appliance should be placed on a dry area steadily and at least 100 mm away from the wall for ventilation. For build-in installation, leave a 80 cm<sup>2</sup> spacing for air intake/exhaust vent and at least 150 mm distance between the bottom of the appliance to the attachment. Keep clear of the air intake and exhaust vent.

#### When using the induction cooker

1. Do not overheat. (Use lower power levels for preheating.)
  - If a small quantity of oil is used and heated excessively, the oil temperature will rise rapidly and the oil may catch fire.
  - If the bottom of the pot is thin or curved, it may become red-hot.
2. Do not leave the appliance unattended.
3. Never heat the empty cookware. Otherwise the appliance may overheat, malfunction and top plate discolor.

#### The top plate and the top frame become very hot

1. Do not touch the appliance during or after use for a while. (Especially when the hot caution indicator [🔥] / [H] lights up.)
2. Clean the appliance after cooled down.  
(Avoid touching the top plate after use for a while, because high temperature remained due to the heated cookware.)

#### For the top plate

1. Do not place portable gas burners, petroleum gas cylinders or canned food on the top plate. They may explode if they are mistakenly heated.
2. Use only the cookware with a flat and clean bottom as mentioned in the manual and ensure it is steadily placed onto the top plate. Otherwise, the sensor of the appliance may be malfunction and causes abnormal heating, which may affect the operation of the appliance.
3. Metallic objects or magnetic material such as knives, forks, spoons, lids, aluminum foil / tray, retort pouch, magnetic ring, watch or accessories should not be placed on or near the surface of the top plate, or in contact with the cookware when the appliance is operating since they may get hot. (They may cause burns or injuries by heat generated.)
4. Do not subject the appliance to a crash. (e.g. Drop heavy object on the top plate, etc. Otherwise, it may cause invisible cracks under the plate. Without checking by Shun Hing Electric Service Centre Limited but kept using the appliance may cause further cracks and danger.)

\*\*\* Warning: If the top plate is cracked due to subjection to a crash or heavy object felt, stop using immediately and do not touch the top plate, switch off the appliance and unplug the appliance. In order to avoid the possibility of electric shock, short circuit or fire, contact Shun Hing Electric Service Centre Limited immediately for checking and repairing.

#### For the cookware

1. Specific cookware should be used on induction cooker only. Do not attempt to use it on other gas cookers. Never use it alternatively as it may affect the cooking result.
2. Before placing cookware on top of the ceramic plate, make sure that there is no water, oil or other attachment at the bottom of cookware or on the top plate. If so, clean it before using the appliance.

#### Avoid deep-frying cooking

1. Overheated oil may catch fire and damage to internal electrical elements during deep-frying, as the appliance does not equip with oil temperature control system. Always heat fat bit by bit, and keep watching as it heats up.
2. If oil or fat catches fire, switch off the appliance immediately. Do not put out the flames with water. Use suitable fire extinguisher or fire blanket instead.

#### For the IH heaters

1. Keep all combustible materials, spray canisters and aerosols away. It may possibly cause fire or explosion.
2. Do not allow unaccustomed people using the appliance without supervision.
3. The appliance is not intended to use by persons (including children) with reduced physical, sensory or mental capabilities, or lack of experience and knowledge, unless they have been given supervision or instruction concerning the use of the appliance by the person responsible for their safety.
4. Do not heat any sealed can food directly to avoid explosion caused by air expansion.
5. Pay attention to the cooking status to avoid overheating or empty heating. Otherwise, the overheat protection will be activated and the appliance will be switched off automatically when the temperature is too high. It may affect the cooking result.
6. Great care is necessary in using the appliance, especially near children. Children should be supervised to ensure that they do not play with the appliance. Also, children without adult supervision should not operate the appliance and keep them away from the appliance and its power cord.
7. Keep it out of reach for infants.
8. Do not insert metallic object (such as pins or wire etc.) into the air intake/exhaust vent.
9. The appliance is not intended to be operated by means of an external timer or separate remote-control system.
10. Always place the cookware at the center of the cooking zone during operation. Heat the bottom of the cookware directly. Never place paper or other objects between the cookware and the top plate. (Objects may possibly get burnt due to high temperature at the bottom of the cookware.)
11. The appliance equipped with high voltage, do not disassemble, and attempt to repair, or modify the appliance. For repairing, please contact Shun Hing Electric Service Centre Limited.
12. If the supply cord is damaged, it must be replaced by Shun Hing Electric Service Centre Limited to avoid hazard.

### Switch off the main power after use

1. After use, switch off the appliance by pressing [ⓘ] key. After the prolong operation of the cooling fan, unplug the appliance from the socket. Do not rely on the pan detector to turn off the appliance.
2. When not in use for a long time, shut down and unplug the appliance to avoid damaging the electronic elements or even causing fire due to long-term connection with the electricity.
3. Keep the appliance clean, pay attention to pest control, dust and moisture protection. Protect the appliance against cockroaches and other insects from entering the interior of the appliance to avoid short circuit.

### 1.2 To prevent ignition or accidents

#### Beware of the following in order to avoid accidents

1. Ingredients or hot water may spout infrequently during heating. This phenomenon is called bumping. Check the cooking status carefully and stir the ingredients occasionally by using a low heat level especially when simmering or heating.
2. If you wear a cardiac pacemaker or cardiac defibrillator, consult with doctor. (The operation of the appliance may affect the pacemaker and defibrillator.)
3. The cookware must be used and rested on a stable surface. (If the cookware felt off, it may cause injuries or burns.)
4. Avoid empty heating or overheating. (Ingredient may get fire and damage the cookware. It may also damage the appliance and the top plate, or lead to other hazards, etc.)
5. Keep the installation of the appliance away from the place of massive hot gas, steam, damp and heat place or water source so as to prevent water penetrating inside the appliance.
6. Do not rinse the appliance, the power cord or the plug with water directly. Do not let it get in touch with water or allow liquid to penetrate the electrical parts of the appliance. Do not immerse part or the whole appliance into water when cleaning. Otherwise it may affect the insulated parts and cause a risk of electric shock. Make sure the power cord is dry before use.
7. Handle the power cord with care, do not place heavy object on or clamp it. Any power cord modification is prohibited. Do not stretch or twist the power cord. Always hold the plug tightly with your hands when unplugging or plugging into the socket.
8. Do not hang the power cord over the edge of table, or counter-top or contact with the hot surfaces. Do not operate the appliance when the power cord is tangled, it may let the power cord be frayed and damaged.
9. Do not install the appliance over a dishwasher, washing machine, dryer, electric oven or refrigerator. It is because high temperature radiation could damage other electrical appliances below, resulting in impairing the appliance's ventilation system.
10. Make sure that only one function key is pressed at a time. Do not place hot objects or cookware on the control panel as the appliance may react wrongly.
11. Do not touch the appliance, plug or unplug the power cord by wet hand.
12. Do not use the appliance for purposes other than cooking. (Use it other than cooking, may cause malfunction.)
13. The appliance is intended to be used in household or similar environments such as: staff kitchen area in shops, offices and other working environments; or clients in hotels, motels and other residential type environments.
14. The appliance is for household or similar environment uses only. Do not use it outdoors and any other uses that are not recommended in this manual. If the appliance is used improperly or for commercial (or semi-commercial) purpose or if it is not used according to the instruction in the user manual, the maintenance guarantee will become invalid and we refuse any liability for damage caused.

15. To prevent hazards occur, when the appliance or parts were malfunction, do not replace with any parts or accessories which is produced without authorization. Otherwise, the maintenance guarantee will become invalid.
16. In order to comply with safety regulations and to avoid hazards, if the appliance needs to be checked or repaired, please contact Shun Hing Electric Service Centre Limited (hotline at 2406 5666 or refer to the address found at the back page of the manual), and be reminded that the official invoice and warranty registration card must be presented for checking or repairing service.

### 1.3 When using the appliance

**The appliance emits magnetic lines of force. Please keep the below items away as if affected by magnetism**

1. Radios, TVs, hearing aids, etc. (They will be susceptible to interference.)
2. Magnetic card, automatic turnstile tickets, bank cards, etc. (The records may be erased or damaged.)

**Do not place the appliance on top of or next to other induction heating devices or metallic plates**

1. Induction rice cooker, induction cooker, etc. (The magnetic field may damage the appliance.)
2. Do not place the appliance on top of any metallic plate during operation. Otherwise, it may damage the appliance, or cause fire and other hazards.

### Noise generated by cookware when heating

1. Resonant sounds may be heard depending on the type of cookware.
2. When holding the handle, user may feel a small vibration.
3. If the cookware is moved when heating, a short metallic sound may be heard. (It may help to alleviate the sound and vibration if the cookware is slightly moved or replaced. To prevent getting burn, do not touch the metallic parts of the cookware directly.)

**Do not place seasoning or food in the cabinet. (Below the appliance)**

The exhaust heat from the appliance may spoil them.

**If acidic food sticks to the top plate or top frame, wipe it off immediately.**

Do not let the residual vinegar, jam or food containing lemon juice or plum sticks to the top plate or top frame. (Otherwise, the top plate or enclosure may be discolored or damaged.)

**Do not rub the top plate against the bottom of cookware**

The top plate may be damaged or discolored.

**Do not clog up the intake/exhaust vent**

(When the intake/exhaust vent is clogged, the appliance may turn off automatically or overheat may cause other hazards.)

1. The intake and exhaust vent can be found at the bottom and the back of the appliance.
2. Do not place the appliance on top of carpet, tablecloth, paper sheet or mat etc. (If the intake/exhaust vent is clogged, it may cause malfunction.)

### Do not use steam cleaner to clean the appliance

If water penetrates to the electrical parts inside the appliance, it may cause malfunction or other hazards.

#### 1.4 When using the power level [8]

1. The appliance is with strong heating power. If high power level is used in small portion of oil, the cookware may be heated excessively. Oil temperature will rise rapidly and may cause accident.
2. If the bottom of the cookware is thin, overheat may cause the bottom of the cookware to be deformed. Therefore, preheat the cookware with low power level when using thin bottom cookware or small portion of oil.
3. When boiling water, turn down the power level as soon as the water was boiled. (Water may boil over or splash around.)
4. When using power level [8], do not put ingredients in the cookware. (Ingredients may boil over.)
5. Attention! Power level [8] is with time limitation as safety protection, it will reduce to power level [7] after used for 10 minutes.

## 2. Maintenance and Cleaning Methods

1. Switch off the appliance by [⏻]key and remove the power plug from the socket before cleaning.
2. Cleaning of the top plate: When the top plate is dirty, use a wretched damp cloth to wipe. If object can not be wiped off, use some mild decontamination powder or detergent to wipe, then using a damp cloth to wipe.
3. Cleaning of the body: When the body is dirty, use a soft damp cloth to wipe. If the greasiness is hard to wipe off, use some mild decontamination powder or detergent to wipe, then using a damp cloth to wipe.
4. Do not use a steam cleaner to clean the appliance.
5. After using a long time, dust and grease may accumulate on the air intake/exhaust vent which may affect the operation. Clean the appliance regularly and make use of cotton stick.
6. Materials including plastic, aluminum foil, sugar, or any foodstuff contain sugar which are already burnt on or have melted on the cooking zone unintentionally. It must be removed or cleaned immediately with soft damp cloth when the top plate is still warm. Otherwise, it may damage the top plate when cool down.
7. Do not use hard brush to clean the top plate and avoid hitting the top plate.
8. Do not use any chemicals such as organic solvent or benzene to wipe the top plate/control panel, so as not to make chemical reaction.
9. The top plate may suffer from damages such as color changes to yellow, black or scratched for improper use (e.g. cook with dirty bottom cookware or do not clean immediately after the overflow of soup etc.). User can avoid or reduce such phenomena if user operate according to the manual and perform daily maintenance.
10. Disconnect the power plug when the appliance not in use for long time. Clean it before packing it in a plastic bag and store in a day place. Never wrap the power cord tightly around the appliance or put any pressure on the power cord when the appliance is stored, as it could cause the power cord to fray and damage.

### 3. Cookware for induction cooker

#### 3.1 Suitable Cookware for Induction Cooker (Magnetic Cookware – A magnet can be stuck to the bottom of cookware)

1. Material: Cookware base is made of iron or magnetic stainless steel. It is necessary to use the cookware stated "Suitable for induction cooking".
2. Shape: Flat bottom base cookware with the diameter in between 120-200 mm and has uniform contact with the top plate.
3. Weight: The maximum weight (including ingredients) must not exceed 6 kg.

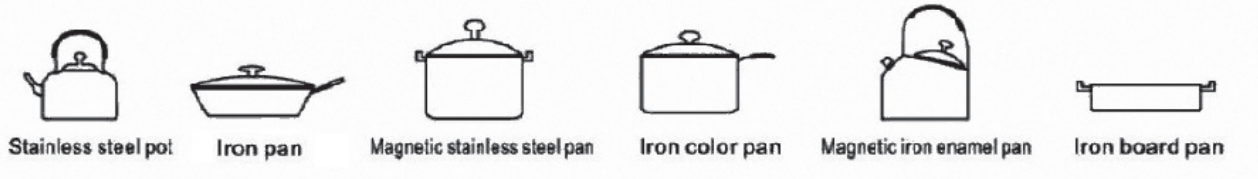

#### 3.2 Unsuitable Cookware for Induction cooker (Non-magnetic Cookware – A magnet cannot be stuck to the bottom of cookware)

1. Material: Cookware base is made of non-ferric metal, stainless steel with non-magnetic base (A magnet will not stick to the bottom of cookware), ceramic, glass, aluminum and copper.
2. Shape: Uneven base, curved, has protrusions or legs; the bottom of the cookware is round. And the bottom diameter is less than 12 cm or larger than 20 cm.
3. Ceramic cookware such as earthen cookware is not suggested to be used, even they are stated for induction heating. Since it is hard to distinguish whether the cookware is magnetic or not, which may result in malfunction, unstable operation, improper cooking, activation of the safety protection function or even operation errors may occur.

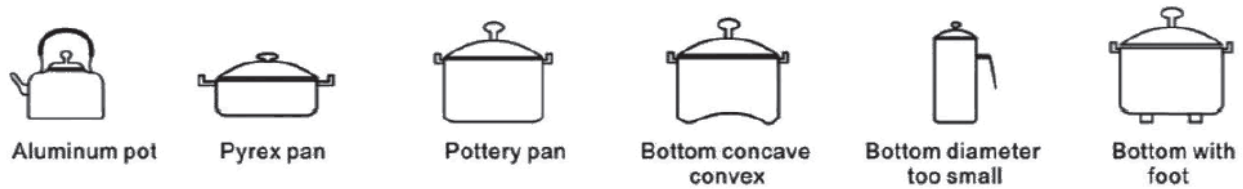

## 4. Product Specifications and Configuration

### 4.1 Product Specifications

Model	RIC-S228E	RIC-S211E
Rated Power (approx.)	Total Power: 2,800W (power sharing) Max. power for each IH heater: 2,800W	
Rated Voltage	220V~ 50Hz	
Unit dimensions (approx.) W x D x H	735 x 435 x 80 mm	650 x 346 x 78 mm
Net weight (approx.)	11kg	9kg
Required cookware size	Base diameter 120-200 (mm)	

### 4.2 Product Configuration

#### Front Side

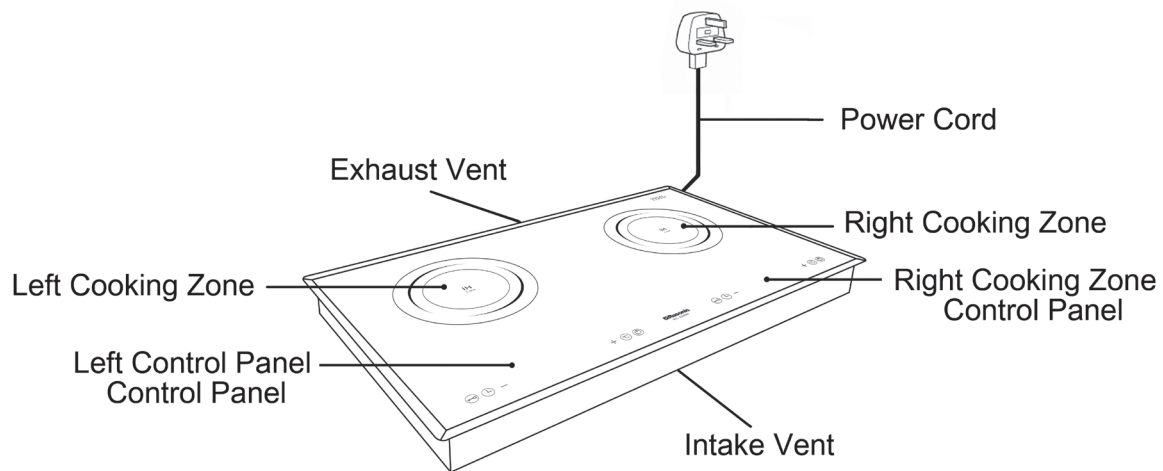

Remark: The product appearance and color are subject to the actual appliance. Above illustration is for reference only.

## 5. Control Panels & Operation Instructions

### 5.1 Top plate design

RIC-S228E Top plate

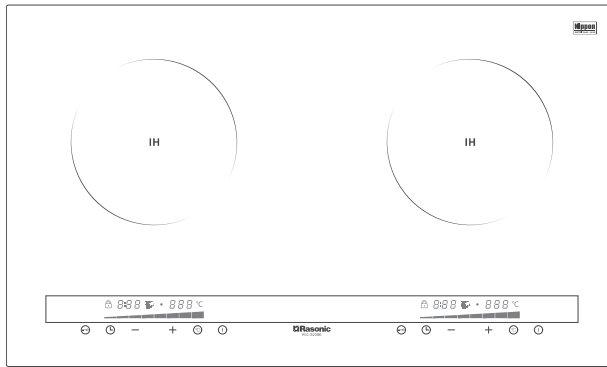

RIC-S211E Top plate

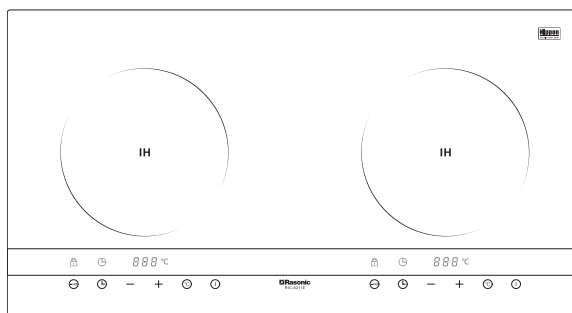

### 5.2 Control Panel

RIC-S228E Control Panel

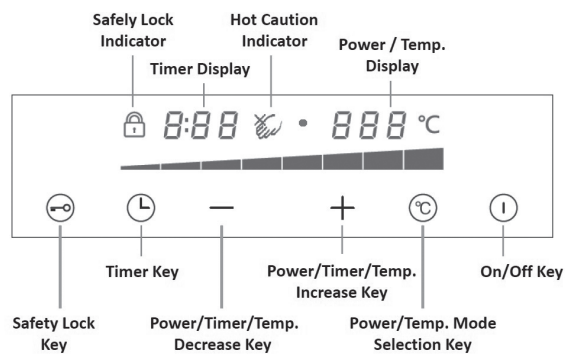

RIC-S211E Control Panel

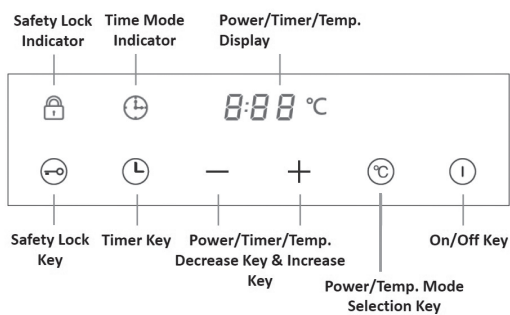

(Remarks: Keep the control panel clean and dry. Otherwise, the electronic sensor of the keys will be program fault or malfunction.)

### 5.3 Power and Temperature Controls

Power level	1	2	3	4	5	6	7	8
Temperature Control (°C) (approx.)	60	90	120	150	180	200	220	240
Power Control (W) (approx.)	250	400	600	1,000	1,400	1,800	2,200	2,800

- \*\*\* Note:
1. The power and temperature shown above is the mean value of the actual power and temperature in a desired operation period.
  2. Power level [8] is with time limitation as safety protection, it will reduce to power level [7] after used for 10 minutes.

After connecting the power with the appliance, a “Beep” will emit for a second and all the indicator will flash once, known as standby mode. Long press the [ⓘ] key, the display shows [0] and keeps flashing, which means the appliance is ready to use. User can press [ + ] or [⊖] key to select power or temperature. If no function key is pressed for approx. 1 minute, the display will turn off automatically and the appliance will return to standby mode.

#### Power control

Long press the [ⓘ] key, the indicator will display [0] and the buzzer will emit "Beep" sound at the same time. Place a suitable cookware at the cooking zone of the top plate, then press the [ + ] key, power level indicator will show [4] or power level correspondingly, meaning that the appliance is now operating under default power level 4. User can press [ + ] or [ - ] key again to adjust a desired power level. There are totally 8 power levels for both IH heaters.

#### Temperature control

Long press the [ⓘ] key, indicator will display [0]. Place a suitable cookware at the cooking zone of the top plate, temperature control can be activated by pressing the [⊖] key, display will show [60°C] meaning that the appliance is now operating under default temperature 60°C. User can press the [ + ] or [ - ] key again to adjust a desired temperature level. There are totally 8 temperature controls for both IH heater.

The appliance works under power sharing technology. If both IH heaters are operating simultaneously, one heater will be frozen automatically when power level [8] is set, vice versa.

Remark: If no suitable cookware placed at the cooking zone, “Beep” sound will keep emitting even power/temperature control have been set. The power/temperature level indicator will keep flashing to remind user. The appliance will return to standby mode automatically if no suitable cookware placed within 1 minute.

### Timer Setting

After selecting the power/temperature control, press the [L] key to activate the timer function, display will show [0:00]. User can press [ + ] or [ - ] to adjust cooking time, and time can be circulating from 1 minute to 8 hours. When it comes to [0:59], the timer will change to [1:00] if [ + ] key is pressed once again, meaning that the setting time changed from 59 minutes to 1 hour. To increase the speed, press and hold the [ + ] or [ - ] key to advance rapidly; changing from 1 minute to 10 minutes by each increase or decrease.

**RIC-S228E:** When approx. 10 seconds elapsed without any modification, the time indicator on the display will stop flashing and be confirmed automatically. Time will start counting down and remaining time will be shown on the display. To adjust the time setting, user can press the [L] key once, the remaining time will flash again, then press the [ + ] or [ - ] key to reset the timer. The appliance will confirm automatically 10 seconds after completion of the setting and start operating.

**RIC-S211E:** After timer setting, the appliance will directly confirm and start operating. To adjust the time setting time, user can press [ + ] or [ - ] key to adjust the [Timer] time. To adjust the setting of power/temperature control, user can press the [L] key once, power / temperature level will show on the display correspondingly, then press the [ + ] or [ - ] key to reset the power / temperature level. After completing the setup, the appliance will automatically confirm and start operating.

[Timer] time will display the remaining time in a countdown mode. When the countdown is finished, the appliance returns to standby mode automatically after a "Beep" sound and [End] will be shown on the display.

Timer function will be cancelled by long pressing the [L] key or simply press the [I] key once.

### Safety Lock function

To prevent children accidentally operating the appliance or changing the function modes, press and hold the [⊖] key for 2 seconds, safety lock indicator [🔒] will light up, all the function keys are locked (including [ + ], [ - ], [°C] and [L] keys), where the operating modes, power, temperature and time can not be adjusted. During the activation of the safety lock, the safety lock indicator [🔒] will light up on the display.

The lock is deactivated under standby mode. Press and hold the [⊖] key for 2 seconds, safety lock indicator [🔒] indicator will light up on the display, which means all function keys are locked. To deactivate the lock by pressing and holding the [⊖] key again for 2 seconds. A "Beep" sound will emit and the appliance is resumed for operation.

If both [Timer] and [Lock] are activated at the same time, remaining time will still be shown on the display.

All the function keys are locked (except [I] key). Press and hold the [⊖] key for 2 seconds to deactivate the safety lock and resume all the function keys.

If user stop the operation directly by pressing the [I] key, the safety lock [⊖] indicator will still light up until deactivation of the lock. User must press and hold the [⊖] key to resume the operation before next operation; otherwise, the lock remain active. If cut off the power supply directly, the lock will be deactivated and all the function Keys will be unlocked when re-connecting the power again.

### Absent-minded shut down protection

When approx. 120 minutes elapses without any external interruption during heating, a "Beep" sound will be heard and the appliance will be shut off automatically as protection. Use the timer function if the heating time longer than 120 minutes.

### Cooling Fan Prolong Operation.

After using the appliance, press the [I] key to stop operation. The appliance will change to standby mode and display will show [🌀] / [H]. Please be reminded that the cooling fan will continue to operate in order to suppress the temperature rise in the main unit.

### Hot Caution Indicator

After finishing the operation, if the temperature of top plate reaches 50°C or above, the hot caution indicator [🌀] / [H] will be flashing/ statically lighted, meaning that the top plate still hot, do not touch it.

### Error Code

When there are some problems or using the appliance incorrectly, the respective error codes (E1 to E7) will be shown on the display. Operation will stop and generate discrete warning sound. (Please refer to the check points and remedy shown on **Chapter.6 Troubleshooting and Treatment**)

## 6. Troubleshooting and Treatment

During operations, if any errors occurred, please check the following table before calling for service. Below are common errors and the checks to perform.

Symptom	Check points	Remedy
After connecting the power and pressing the [⏻] key, the appliance has no response. The control panel and display light out.	Is the electricity in suspension?	User after resuming the electricity.
	Is the fuse blown out?	Check the root causes carefully. If the problem cannot be fixed, please contact Shun Hing Electric Service Centre Ltd. for checking and repairing.
	Is the power plug connected firmly?	
Operation being interrupted during normal use and E7 error shown.	Any water accumulated covering the control panel?	Wipe off the accumulated water by soft dry cloth.
	Any damp cloth or magnetic object are place on the control panel?	Take the damp cloth or magnetic object away form the control panel.
The buzzer sounds discontinuously and cookware was not heated up.	Incompatible cookware is used?	Use compatible cookware for the induction cooker.
	Is the cookware not placed at the center of the cooking zone?	Place the cookware at the center of the cooking zone.
	Cookware is removed during heating?	Place a cookware on the cooking zone.
Operation being interrupted during normal use and E4 error shown.	Incompatible installation, poor ventilation.	Install the appliance appropriately and keep good ventilation.
	Is the intake/exhaust vent clogged or dirt accumulated?	Remove the dirt clogged in the intake/exhaust vent.
	Ventilation fan stop operate	Please contact Shun Hing Electric Service Centre Ltd. for checking and repairing.
	Ambient temperature too high	Switch off the appliance and switch on again after it is cooling down naturally.
Operation being interrupted during normal use and E3 error shown.	Is the cookware empty?	Put ingredients into the cookware, and restart the appliance when cooled down.
	The ingredients' and cookware temperature too high?	Lower the power or temperature level, or switch on the appliance after it is cooling down naturally.
Operation being interrupted during normal use and E1 or E2 error shown.	The input voltage unmatched with the related voltage.	Make sure the input voltage match the rated voltage marked on the appliance before operation.
Operation being interrupted during normal use and E5 or E6 error shown.	Temperature sensor error	Contact Shun Hing Electric Service Centre Ltd. for checking and repairing.

### Error Code

- E1 – Under voltage protection error
- E2 – Over voltage protection error
- E3 – Top plate temperature is too high
- E4 – Overheat protection
- E5 – Top plate temperature sensor error
- E6 – Temperature sensor error
- E7 – Control panel protection

If the above remedies/solutions cannot fix the problem, switch off and unplug the appliance immediately, contact Shun Hing Electric Service Centre Ltd. (Tel: 2406 5666) for inspection and repairing. To avoid any danger and damage to the appliance, do not disassemble or repair it by yourself.

## 7. Special Avowal

1. This information above has been checked; our company reserves the hermeneutic power to any print errors or misunderstanding on the content.
2. Please note that any technology improvement will be added to the new versions of operation manual without any prior notices. The product appearance and color are subject to the actual appliance.
3. In case there is any inconsistency or conflict between the English versions and Chinese versions of the terms, the Chinese versions shall prevails.
4. E-copy of operation manual can be sent by e-mail on request, please call Shun Hing Electric Works and Engineering Co., Ltd at 2861 2767.

## 8. After Sales Service

Guarantee period states from the date of purchasing to one year. If the appliance is out of order under proper use, a free repair service is available. Please present the official invoice and the product warranty card with the sales point's chop/redemption center's chop for free maintenance. For enquiries, please contact Shun Hing Electric Service Centre Limited hotline at 2406 5666.

# 備忘錄

---

# 備忘錄

---



 **Rasonic 樂信牌**

## 信興電工工程有限公司

**SHUN HING ELECTRIC WORKS AND ENGINEERING CO., LTD.**

辦公室：香港九龍尖沙咀東部麼地道67號半島中心9樓

電話：2861 2767

圖文傳真：2865 6706

網址：<http://www.rasonic.com>

電郵：[shew@shunhinggroup.com](mailto:shew@shunhinggroup.com)

Office: 9/F, Peninsula Centre, 67 Mody Road, Tsimshatsui East, Kowloon, Hong Kong

Tel: 2861 2767

Fax: 2865 6706

Website: <http://www.rasonic.com>

E-mail: [shew@shunhinggroup.com](mailto:shew@shunhinggroup.com)

保養及維修 Maintenance and Repair Service:

## 信興電器服務中心有限公司

**SHUN HING ELECTRIC SERVICE CENTRE LTD.**

香港新界葵涌勝耀街2號信興中心11樓

服務熱線：2406 5666

傳真號碼：2408 0316

網址：<http://www.shesc.com/zh>

11/F, Shun Hing Centre, 2 Shing Yiu Street, Kwai Chung, N.T. HK

Service Hotline: 2406 5666

Fax No.: 2408 0316

Website: <http://www.shesc.com/en>

客戶服務中心：

香港新界葵涌勝耀街2號信興中心1樓

九龍尖沙咀東部麼地道67號半島中心B座9樓

香港天后琉璃街7號柏景中心22樓

澳門慕拉士大馬路193-199號南嶺工業大廈5樓I座

Customer Service Centre

1/F, Shun Hing Centre, 2 Shing Yiu Street, Kwai Chung, N.T.

9/F., Block B, Peninsula Centre, 67 Mody Road, Tsim Sha Tsui East, Kowloon

22/F, Parkview Centre, 7 Lau Li Street, Tin Hau, Hong Kong

Avenida de Venceslau de Morais, No. 193-199, 5 andar - I, Edf. Industrial Nam Leng, Macau

有關最新之香港及澳門客戶服務中心資料，請參閱信興服務中心網址：<http://www.shesc.com/zh>

For the latest information of Hong Kong and Macau service center, please visit <http://www.shesc.com/en>

RIC-S0823